

Improving the Performance of the KSB2

John Grebenkemper, KI6WX

KI6WX@pacbell.net

July 18, 2002

Last Revision: June 25, 2006

Introduction

The following is a set of changes that I have done to my KSB2 and related circuits to improve the overall performance of the K2 in SSB. These changes include increasing the SSB filter bandwidth, improving the response of the 2nd Xtal Filter, increasing the gain of the KSB2, and reducing intermodulation distortion in the KSB2. Also for completeness, I have included the time constant change in the ALC circuit that allows the KSB2 to work better for PSK31 transmissions that I developed several years ago and is now standard production for the KSB2. Each of these changes can be applied independently of the other ones.

The KSB2 SSB bandwidth is somewhat narrow in the opinion of some operators. Others think it is just fine as it is. The Crystal Filter Bandwidth Modification provides several options to change the standard 2.0 kHz 3 dB bandwidth of the KSB2 SSB filter.

The change to the 2nd Xtal Filter improves the flatness of this filter beyond the current 2nd Xfil SSB Mod posted on the Elecraft web site. The original 2nd Xtal Filter varied by 10 dB over its passband. The 2nd Xfil SSB Mod reduced this to about 4 dB. This change, known as the 2nd Xtal Filter Flatness Mod, reduces it to less than 2 dB.

The KSB2 Increased Gain Modification increases the gain of the KSB2 by about 10 dB. This change is accomplished by adding one transistor and two resistors and is very easy to add to the board. The increased gain also improves the SSB output on 10 meters since the output of the NE602 modulator is fairly marginal on this band.

The KSB2 Reduced Intermodulation Distortion Modification reduces the audio drive level to the NE602 modulator by adding a single resistor. The NE602 will start to clip with a microphone input of 10 mV RMS in SSBC 1-1, and a considerably lower microphone input with compression enabled. This change along with the KSB2 Increased Gain Modification still increases the overall gain of the KSB2 by 4 dB.

These modifications are not *required* for the K2 to function well in the SSB mode. Instead, they are intended for those who wish to optimize its performance.

Removing Parts From the KSB2

The KSB2 is designed with much smaller pad sizes than the other boards in the K2 transceiver. For this reason it can be more difficult to remove parts without damaging the board. The best way to remove parts from a KSB2 is to use a Hakko 808 (or equivalent) de-soldering tool. If interested, the Hakko 808 and tips for it are available at <http://kiesub.com/hakko808.htm>. I was able to remove RP3 from the KSB2 with no damage to the part or the board. Additionally, this tool easily removes the insulation from the enameled wire in a toroid in a few seconds.

If you don't have a desoldering tool, cut the leads off the part and then pull out each piece of wire individually. You will lift pads on the KSB2 if you try to remove capacitors or resistors in one piece. Sacrifice the part and save the board. Crystals may be removed by desoldering the grounding lead on the top and then wiggling the crystal out by alternately heating each pad on the board.

Using Spectrogram To Make Filter Response Measurements

Spectrogram (<http://www.visualizationsoftware.com/gram.html>) may be used to measure the response of the various filters in the K2. To make a measurement of a K2's filter, use the following procedure:

1. Connect a noise generator to the antenna input of the K2. Using antenna noise for this purpose will be much less accurate.
2. Connect the audio output of the K2 to the sound card input on a PC. If you use the headphone output of the K2 for this purpose, be sure to place a 10 ohm resistor to ground to avoid rolling off the high frequencies due to C105/C106.
3. If your K2 has a KAF2 installed in it, be sure to put the KAF2 in bypass mode. If you leave it inline, the higher audio frequencies will start being attenuated and this will decrease your amplitude measurement accuracy.
4. Set Spectrogram at Scan Input to 22k Sample Rate, 16 bit Resolution, Line Plot, 90 dB Scale, 1024 FFT, and Average Count to 32. Then press OK. Move the slider at the right to the top of its range. The displayed spectrum should not exceed -30 dB or you risk overloading the sound card input.
5. Set the K2 to 7100 kHz. Turn AGC Off. Set the AF Gain to about its mid-point. Select the filter for which you wish to measure its frequency response. Adjust the RF Gain so that the maximum level displayed is -30 dB or less.
6. The output may be written to a ASCII file by using the Log Spectrum command. This can then be read into Excel for doing plots. The Spectrogram data in this document was created this way.
7. If you wish to see the SSB filter response without it being modified by the 2nd Xtal Filter, place 0.1uF caps across X5 and X6 on the RF Board.
8. When you have completed the measurements, return the KAF2, if present, to its normal mode. In my opinion, the high frequency rolloff of the low pass filter provides a more pleasant listening experience than the flat response with the KAF2 removed.

Spectrogram provides an easy way to look at the filter responses of all of the K2's filters. You are limited to a dynamic range of less than 60 dB. The noise fluctuations will be several dB, but you can reduce this by increasing Average Count to 128. Additional reductions can be accomplished by averaging several sets of readings.

Crystal Filter Bandwidth Modification

The current version of the KSB2 ships with the 2.2 kHz design as derived in this note. If you have questions about your KSB2 bandwidth, check the capacitors used in the filter.

The KSB2 crystal filter was designed to use commonly available inexpensive HC-49/U quartz crystals. Elecraft improves their performance by sorting the crystals by their series resonant frequency into 10 Hertz bins. This allows the filter to be designed as a standard ladder filter (each element in the filter has the same resonant frequency). However, the motional inductance of these crystals will vary from crystal to crystal, possibly resulting in a final filter bandwidth that can differ by up to a hundred Hertz.

The filter as designed by Elecraft has a 2.0 kHz bandwidth. There is a pronounced dip of 3-4 dB in the filter response near 4915 kHz. This dip will not cause any noticeable audio performance degradation, but I felt the design could be flatter. I measured the response of my KSB2 filter in both receive and transmit modes. I also calculated the expected response of the filter based on measurements I had made on a set of filter crystals provided by Elecraft. This allowed me to calculate a predicted response for the filter along with an expected variation in its bandwidth. The figure below shows the results for the predicted response and the measured results in receive and transmit.

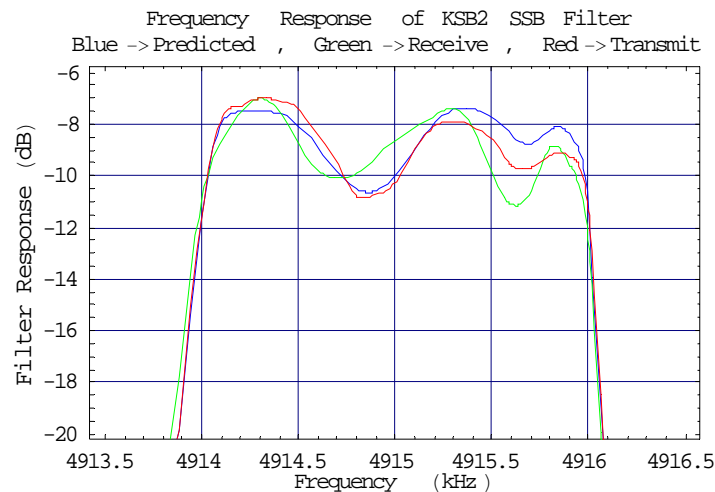

The receive measurements were taken after bypassing X5 and X6 on the RF Board with capacitors and re-peaking L34 for maximum response. The transmit measurements were done by driving the microphone input with an audio oscillator while measuring the transmitter output power. The K2 power level was set to maximum and the audio input then varied to get 1 watt output at a 1 kHz audio frequency. The audio oscillator was then swept from 50 Hz to 5 kHz. This procedure avoids any problem with the ALC impacting the measurements. The predicted curve was calculated using the average measured motional inductance of the crystals used in the filter. All three curves show the same basic shape even though the exact results vary from each other. These results lead me to believe that I can make reasonable predictions of the KSB2 filter response.

The response of a crystal ladder filter can be adjusted by changing the capacitors in the filter. The most critical capacitors are the ones that connect to ground between each pair of crystals. These capacitors set the coupling between the filter sections. The capacitors in series with a

crystal modify the resonant frequency of each section, but are not nearly as critical in value. The challenge in a ladder filter design is to determine capacitors that are available as standard values.

I wrote a computer program that searched standard value capacitors to determine ones that provided a reasonable response and bandwidth. This program determined sets of capacitors that would allow nominal filter bandwidths of 1.9 kHz, 2.2 kHz, and 2.5 kHz in addition to the standard 2.0 kHz bandwidth provide by Elecraft. The table below shows the results.

Nominal BW (kHz)	Predicted 3 dB BW (kHz)	Predicted Loss (dB)	Predicted Ripple (dB)	CA,CP (pF)	CB,CN (pF)	CC,CM (pF)	CD,CL (pF)	CE,CK (pF)	CF,CJ (pF)	CG,CH (pF)
Original	2.01	8.3	3.2	100	10	33	Short	47	56	47
1.9	1.97	7.9	1.1	56	Open	33	Short	47	82	47
2.2	2.26	7.5	1.5	39	Open	27	Short	39	100	39
2.5	2.53	7.3	1.9	39	Open	27	Short	33	150	33

The loss and ripple are predicted by the program. The actual ripple will be greater than the value shown because the Xtal motional inductance differs for each crystal in the ladder network. The CC, CE, CG, CH, CK, and CM must be 5% tolerance or better. These capacitors are available from Mouser (AVX SR15, Type J which is 5% tolerance).

The wider bandwidth filters require that the BFO be tuned to a higher frequency for receiving USB on the lower bands. For the 2.2 kHz bandwidth, the BFO must be able to reach 4916.5 kHz and for the 2.5 kHz bandwidth it must reach 4916.8 kHz. Be sure and check your maximum BFO frequency before attempting to use a wider filter bandwidth. It may be possible to increase the maximum BFO frequency in a K2 by removing turns off of L33 or changing capacitor sizes without raising the minimum frequency too high.

The 2.2 and 2.5 kHz bandwidth filters also require better matching of the crystal motional inductance or else the ripple may become quite large. Elecraft has worked with their supplier to obtain crystals with better control of the motional inductance. The latest ones now make it possible to increase the SSB filter bandwidth up to 2.5 kHz. The older crystals work fine at a 2.0 kHz bandwidth, but will probably not work very well at wider bandwidths. If you want to add a wider SSB bandwidth enhancement to your KSB2, I would suggest you order a new set of crystals from Elecraft. They are Elecraft Part #E850006. The older crystals were shipped before May 2002 and are usually marked with “ECS 4.91-20” or “ECS 4.91-0195” on each crystal.

I measured the response of the KSB2 SSB filter using a network analyzer and resistive matching network to match the 1200 ohm input and output impedance of the filter. The results are plotted for the Original Capacitors, the 2.2 kHz set of capacitors, and the 2.5 kHz set of capacitors. The 1.9 kHz capacitors were not measured, but the bandwidth will be very similar to the Original Capacitor design with a flatter passband. The measurements were obtained using a set of the crystals that Elecraft is currently shipping with new KSB2's.

**Measured KSB2 Filter Response
ECS 4.9136-S Crystals**

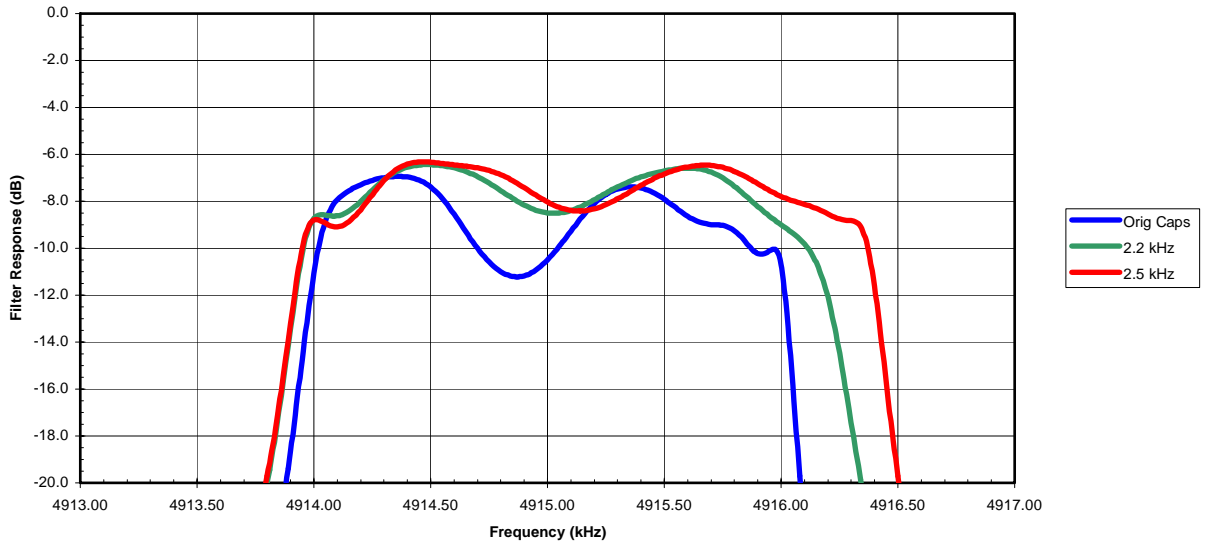

The following table was calculated from the above measurements and shows the insertion loss, the 3 dB bandwidth using the insertion loss as the reference level, and the noise bandwidth of each of these filters. The noise bandwidth is generally a better measure of how much noise will pass through the filter and is normally slightly wider than the 3 dB bandwidth. If you compare the measured results with the predicted results, you will see that the insertion loss is nearly the same as predicted, but the 3 dB bandwidth is slightly less than predicted. The ripple is significantly larger than predicted; this is primarily due to variations in the motional inductance of the crystals and variations in the actual capacitor values.

Filter	Insertion Loss (dB)	3 dB Bandwidth (kHz)	Noise Bandwidth (kHz)
Original Caps	8.3	2.01	1.96
2.2 kHz	7.6	2.20	2.32
2.5 kHz	7.4	2.44	2.52

I modified my KSB2 SSB filter with the 2.2 kHz bandwidth capacitors. The results are shown in the attached plot. This measurement was done in receive mode using Spectrogram and includes the effects of my modified 2nd Xtal Filter. There is some rolloff at the more extreme frequencies in the filter and higher ripple than predicted by the table. Both of these are probably due to the variation in the crystal motional inductance and the additional effects of the 2nd Xtal Filter.

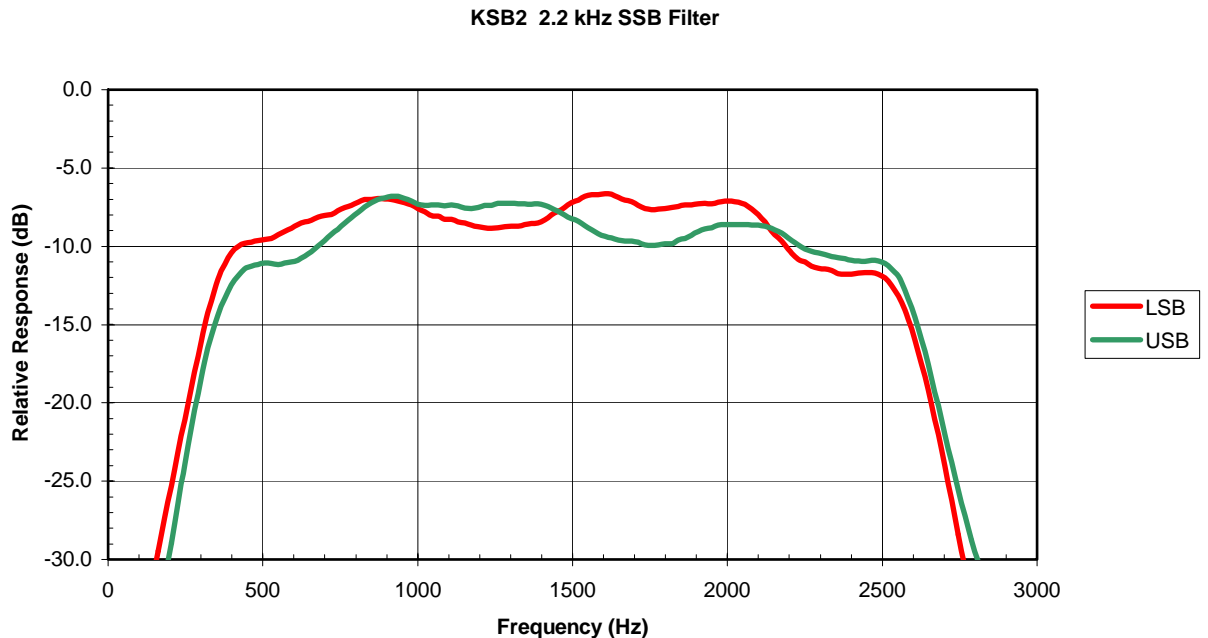

Improved 2nd Xtal Filter Flatness Modification

This change has shipped in the K2 since Serial #3000.

The original design of the 2nd Xtal Filter located on the RF Board was not very flat at SSB bandwidths. A modification to this was designed by N6KR and written up by N0SS. This modification is on the Elecraft web site and is known as the 2nd Xfil SSB Mod. This greatly improved the flatness of this filter. When I analyzed this change, I discovered that the actual input impedance of the NE602 is about 4k, not its specified level of 1.5k. With this piece of information, I was able to modify the original modification and achieve a much flatter response. On my K2, it is almost impossible to hear any difference in the noise background when switching between LSB and USB.

If you want to try this change, the steps for doing it are listed below. This change has been applied to a number K2's, but it has not been checked or approved by Elecraft. The change will increase the 2nd Xtal Filter insertion loss by 2 dB, but it will not have any effect on receiver sensitivity since this filter is at the end of the IF amplifier.

The change may be installed with the following steps:

1. Go to http://www.elecraft.com/Apps/new_fil_docs/k2_2nd_xfil_ssb_mod.pdf. Install this modification in your K2 if it is not already present.
2. Replace the 120pF capacitor in the above mod with a 100pF capacitor (10% tolerance or better).
3. Install a 5.6k resistor from pin 1 of U11 to pin 2 of U11 on the RF board.

4. Check the adjustment of L34. In CW mode, tune to the weak birdie heard at 7 MHz. Set the filter bandwidth to 0.1 kHz and tune L34 for maximum signal relative to the background noise.

The measured response of the 2nd Xtal Filter is shown below. The filter response was measured using Spectrogram with the KSB2 SSB Xtal Filter bypassed by removing the KSB2 and inserting a 0.1 uF capacitor between Pin 1 of J9 and Pin 1 of J10.

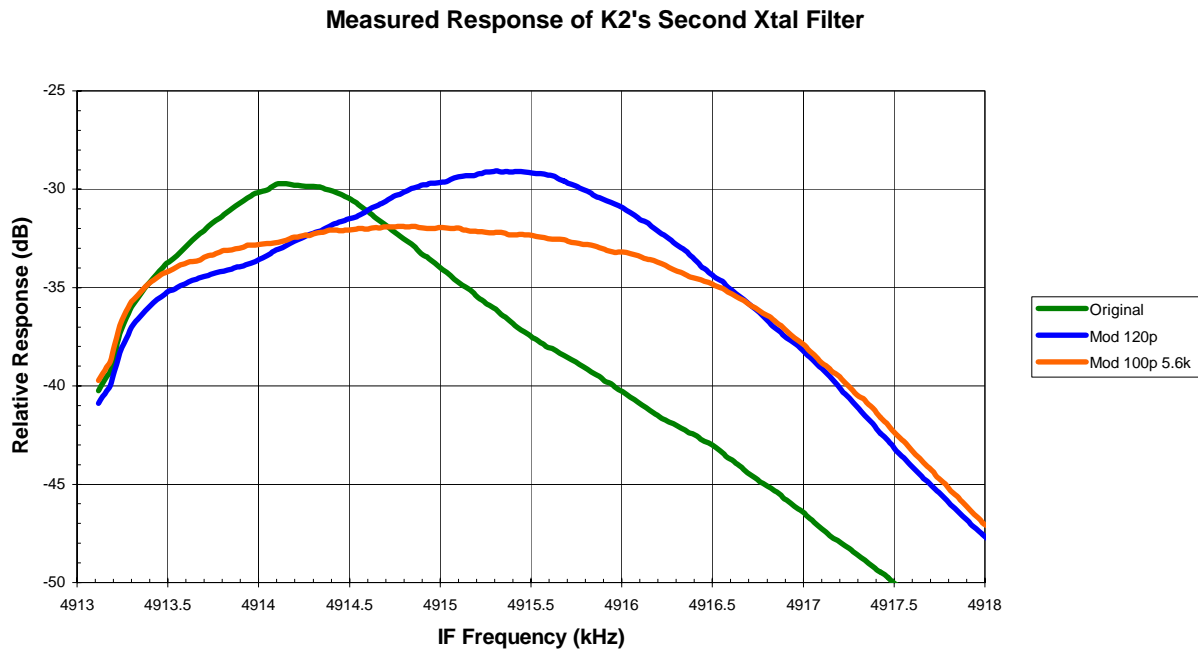

The K2's 2nd Xtal Filter needs to be as flat as possible from 4914 to 4916 kHz with the standard SSB filter. With the wider filters, it may need to remain flat up to 4916.5 kHz. The original design, shown in Green, had a sharp high frequency rolloff with 4916 kHz being 10 dB below the peak response. This resulted in lots of high frequency attenuation in LSB and lots of low frequency attenuation in USB on the bands below 21 MHz.

The 2nd Xfil SSB Mod, shown in Blue, switched a 120 pF capacitor across the 2nd Xtal Filter input in the OP1 filter position. This flattened the response considerably, but now 4914 kHz was about 4 dB below the peak response and in LSB there was now some low frequency attenuation of the received signal.

My change, which for clarity I will call the 2nd Xtal Filter Flatness Mod, is shown in Red. It further flattens the 2nd Xtal Filter response so that it varies by less than 2 dB across the entire filter passband and has a peak response near the center of the passband. This change has no significant effect on the CW response of the 2nd Xtal Filter.

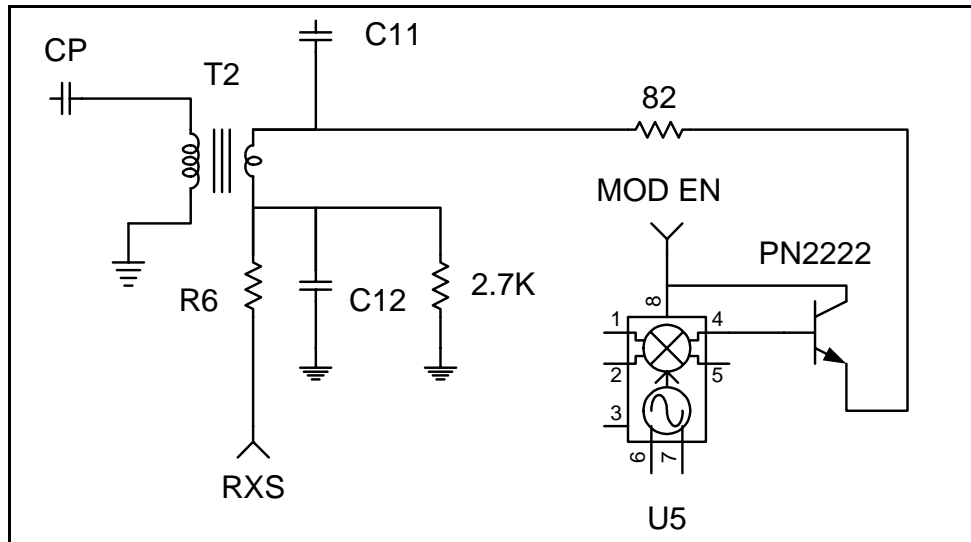

The change is rather easy to implement on the KSB2 using the following steps.

1. Remove D4.
2. Unsolder Pin 2 and Pin 4 of T2. This part is located beside the NE602.
3. Connect the Green wire of T2 to Pin 4. Connect the Red wire of T2 to Pin 2. This reverses the two ground side leads of transformer T2.
4. Install a PN2222 with the flat side next to the NE602 nearest T2 with the leads facing up. Connect the collector to Pin 8 of the NE602. Connect the base to Pin 4 of the NE602. Run an 82 ohm resistor between the emitter and Pin 1 of T2; C11 makes a good connection point.

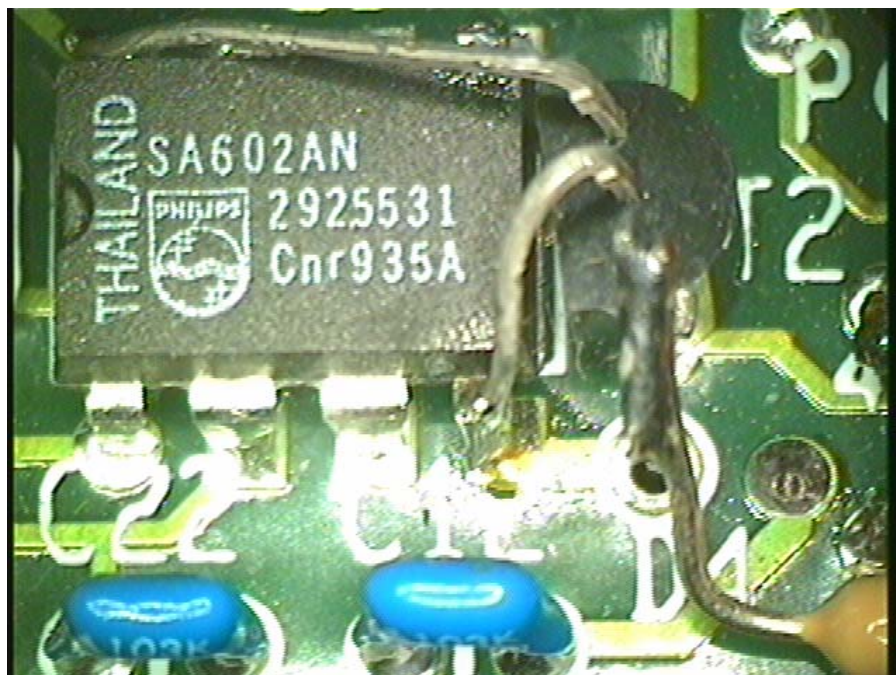

This change has worked well in the two K2's that have been modified using it. It certainly will help anyone who has a low output microphone. Additionally, it provides the increased gain that allows a reduction in the audio drive level at the input of the NE602, which is described in the next section.

KSB2 Reduced Intermodulation Distortion Modification

The audio drive level at Pin 1 of the NE602 is sufficient to cause hard clipping and its accompanying audio intermodulation distortion. This may not be entirely a bad thing for voice communication. In earlier days, diode clipping of the audio signal was often used as a means to increase the average talk power. This was an early form of signal processing. For data signals, particularly those that amplitude modulate the signal, the clipping is a bad thing.

The K2 contains a sophisticated signal processing chip that can greatly compress audio with no intermodulation distortion. We should use that chip to perform the compression and not create extra intermodulation distortion of the audio signal by clipping in the NE602. IMD does not increase the ability to communicate in marginal conditions.

This change adds one resistor to the KSB2. The change assumes that R2 has not been changed in a past attempt to increase the gain of the KSB2. The net result will be some soft clipping of voice peaks, but the hard clipping in the NE602 will be eliminated. The change can be accomplished in the following steps.

1. If R2 is changed, restore it to its 5.6K value.
2. Add a 2.2K resistor between Pin 1 and Pin 2 of U5. This is accomplished by soldering the resistor between the two ends of pot R1. Alternatively, the resistor may be soldered on the bottom of the board between these same two pins.

The following curve will show the reduction in IMD from this modification. The two tone test signal was driven to the signal input of the microphone connector at a level of 10 mV RMS with SSBC set to 2-1. The output power was set to 2 watts. The reduction for in-band audio intermodulation distortion is 15-20 dB. The IMD is even worse if SSBC is set to 3-1 or 4-1. These results were taken for LSB on 40 meters, but similar results are seen on USB.

KSB2 Two Tone LSB Intermodulation Distortion

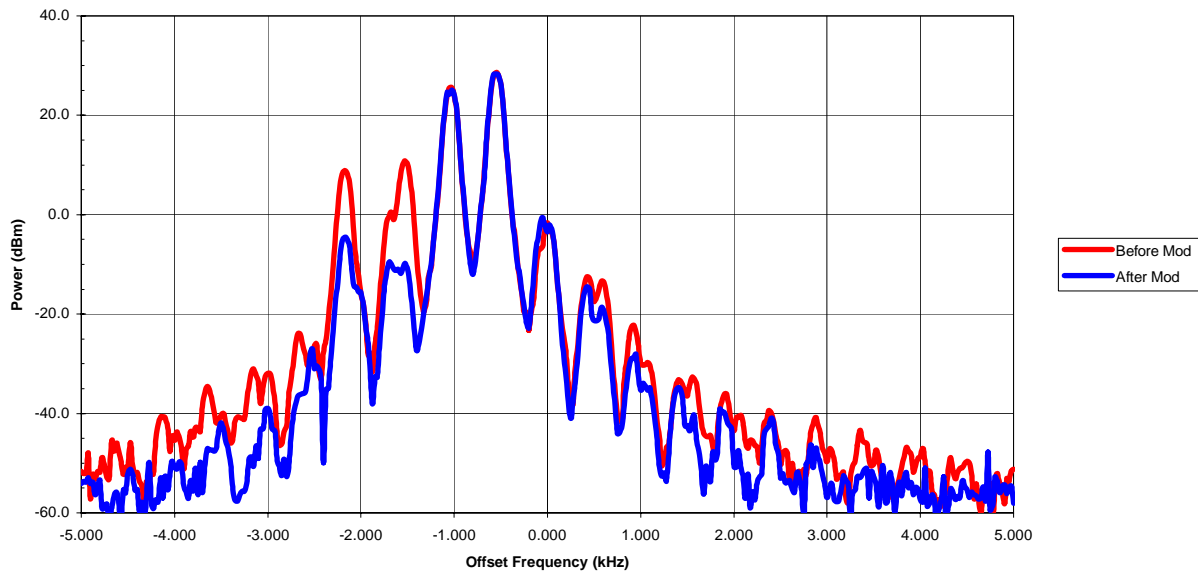

This change should only be done if the KSB2 Increased Gain Modification has also been added. The net results of both changes will be an increased gain in the KSB2 of about 4 dB. This is enough gain to overcome the marginal SSB drive on 10 meters, but may not be enough additional gain for a low output microphone. If your microphone has low output and you cannot get to full power on 10 meters, then you may not want to apply the Reduced Intermodulation Distortion Modification.

PSK31 KSB2 ALC Time Constant Change

This change is included in the current production runs of KSB2.

This change was originally described in the fall of 2000. The change modified the time constant of the KSB2 ALC circuit so that it would not cause distortion during a PSK31 transmission. This change had now been incorporated into the production of the KSB2. This change will work better at low power levels (<3 watts) if you upgrade to the latest version of the KSB2 firmware, version 1.07.

KSB2 PSK31 ALC Modification		
Part Designation	Original Value	New Value
C38	2.2 uF	47 uF
R4	390K	56K
R7	3.9K	33K
R9	3.9K	10K

Conclusion

The above set of changes improve the performance of the KSB2 SSB board in the K2 transceiver. Each change may be done independent of the others except that the Reduced Intermodulation Distortion Modification should only be applied if the KSB2 Increased Gain Modification has also been added. Except for the PSK31 ALC Modification, none of these changes have been tested or approved by Elecraft.

Thanks to Tom Hammond, N0SS, for reading this document and making many suggestions that have been incorporated within it. Wayne and Eric of Elecraft also provided help and parts in making these changes to their design. They created the original design and I have only tweaked it to get slightly better performance.